

# Crystal Clear Technology

## Product Specification

### **C220x04 series**

Crystal Clear Technology sdn. bhd.

16Jalan TP5—Taman Perindustrian Sime UEP  
47600 Subang Jaya—Selangor DE  
Malaysia. T: +603 80247099 F: +603 80247098

---



1.0 Table of Contents

|   | Page    |
|---|---------|
| 1. Table of Contents                        | 1       |
| 2. Record of revision                       | 2       |
| 3. General specification                    | 3       |
| 4. Absolute maximum ratings                 | 4       |
| 5. Electrical characteristics               | 4       |
| 6. Environmental requirement                | 4       |
| 7. LCD specification                        | 5 ~ 7   |
| 8. Interface                                | 8       |
| 9. Timing characteristics / Timing diagrams | 9 ~ 11  |
| 10. Application Block Diagram/Circuit       | 12      |
| 11. Instructions                            | 13 ~ 15 |
| 12. Quality assurance                       | 16 ~ 19 |
| 13. Precautions in use LCM                  | 20 ~ 21 |
| 14. Outline drawing                         | 22      |



2.0 Record of revision

| Rev | Date     | Item | Page | Comment         | Originator | Checked By |
|-----|----------|------|------|-----------------|------------|------------|
| 1.0 | 04/06/08 |      |      | Initial Release | Syam       | Azhar      |



**3.0 General specification**

Display format: Characters 2 x 20 COG

Character size: 5 x 8

Character size: 2.45mm x 5.55mm

View area: 61.0mm x 15.1mm

Active area: 58.5mm x 11.6mm

General dimensions: 69.5mm x 25.1mm

Controller/Driver: NT7605 or equivalent

Microprocessor interface: Parallel (Connection: Pinning)

Driving Method : 1/16 duty, 1/5 bias

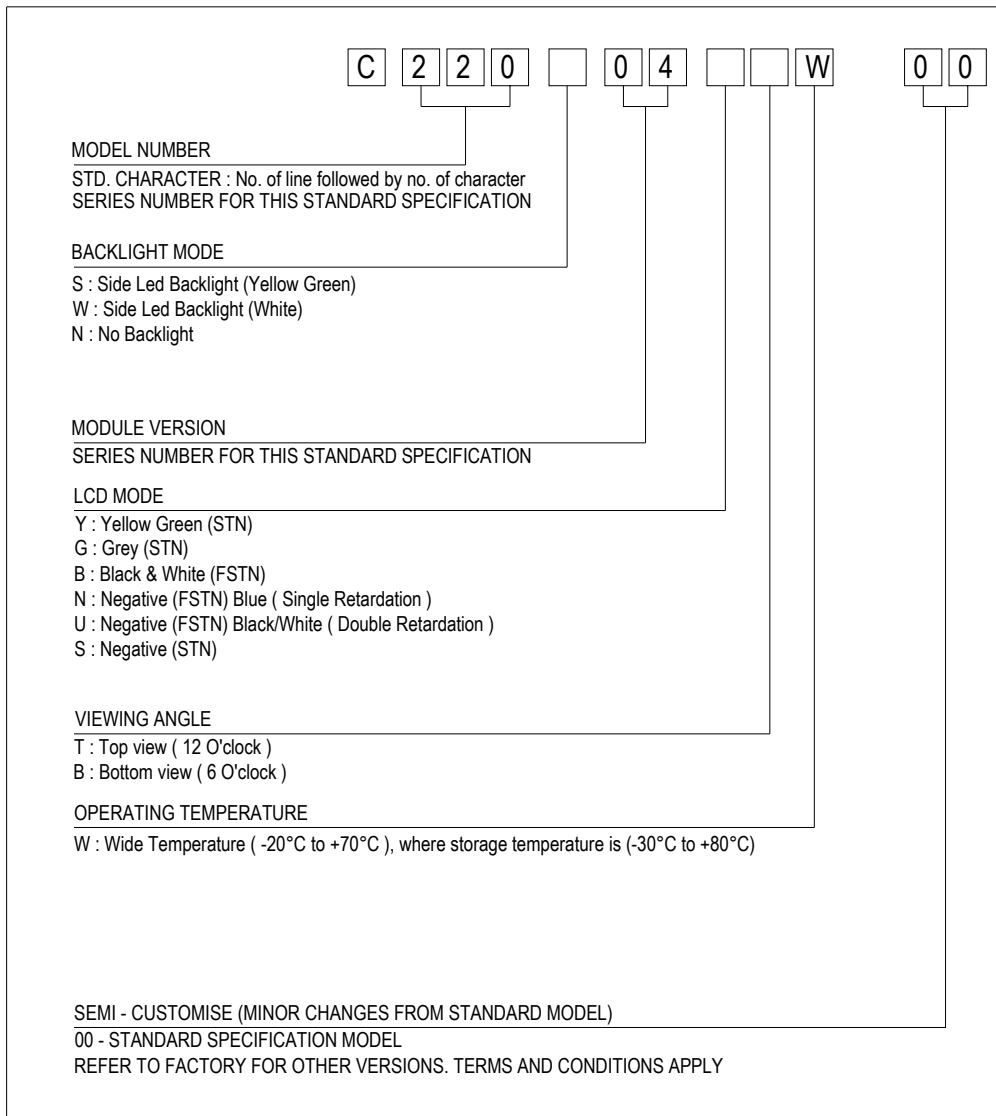

**4.0 Absolute maximum rating (at V<sub>ss</sub> = 0V, ambient temperature = 25°C)**

| NO | ITEM                         | SIMBOL          | MIN          | MAX | UNIT |
|----|------------------------------|-----------------|--------------|-----|------|
| 1. | Power Supply voltage (Logic) | V <sub>DD</sub> | -0.3         | 7   | V    |
| 3. | Operating Temperature        | T <sub>op</sub> | Refer page 3 |     | °C   |
| 4. | Storage Temperature          | T <sub>st</sub> | Refer page 3 |     | °C   |

**5.0 Electrical characteristics**

| NO | ITEM                                     | SYMBOL                          | CONDITION            | MIN    | TYP | MAX | UNIT |
|----|--|---------------------------------|----------------------|--------|-----|-----|------|
| 1. | Power Supply voltage (Logic)             | V <sub>DD</sub>                 | -                    | 4.5    | 5.0 | 5.5 | V    |
| 2. | Power Supply voltage (V <sub>LCD</sub> ) | V <sub>DD</sub> -V <sub>5</sub> | 25°C                 | 4.5±5% |     |     | V    |
| 3. | Current Supply                           | I <sub>DD</sub>                 | V <sub>DD</sub> = 5V | -      | 1.0 | 1.5 | mA   |

**5.1 Backlight Options**

| NO | COLOR        | FORWARD VOLTAGE (V) |      |     | FORWARD CURRENT (mA) |      |     | MIN BRIGHTNESS (cd/m <sup>2</sup> ) * |
|----|--------------|---------------------|------|-----|----------------------|------|-----|---------------------------------------|
|    |              | Min                 | Typ. | Max | Min                  | Typ. | Max |                                       |
| 1. | Yellow Green | -                   | 4.1  | -   | -                    | 20   | 40  | 1                                     |
| 2. | White        | -                   | 4.0  | -   | -                    | 30   | 40  | 60                                    |

- \*Note : 1. Brightness measured at backlight surface.  
 2. On LCD surface, brightness is only about 10% to 15% of backlight brightness.  
 3. Lifetime of backlight: For YG = 50K hrs. For White = 20K hrs

**6.0 Environmental requirements**

| NO | ITEM                  | CONDITION  |
|----|-----------------------|--|
| 1. | Operating Temperature | Refer page 3   |
| 2. | Storage Temperature   | Refer page 3   |
| 3. | Operating Humidity    | 5% to 95%RH  |
| 4. | Cycle Test            | 0 C @ 30 min to 50 C @ 30min for 1 cycle run for 10 cycles |
| 5. | Lifetime              | 50000 HOURS (excluding backlight)                          |

Note: The background on LCD has the possibility to be changed in different temperature range.



## 7.0 LCD specification

## 7.1 Electro-optical characteristics (at ambient temperature = 25°C)

| NO | ITEM                     | SYMBOL          | CONDITION                          | LCD TYPE  |             |                    |                    |                     |                            | REF.  |
|----|--------------------------|-----------------|------------------------------------|-----------|-------------|--------------------|--------------------|---------------------|----------------------------|-------|
|    |                          |                 |                                    | STN<br>YG | STN<br>GREY | STN<br>-VE<br>BLUE | FSTN<br>+VE<br>B/W | FSTN<br>-VE<br>BLUE | FSTN<br>-VE<br>TRUE<br>B/W |       |
| 1  | Operating Voltage (Volt) | $V_{LCD}$       | $\theta = 0$<br>$Cr = \max$        | 4.5 ± 5%  |             |                    |                    |                     |                            | 7.1.1 |
| 2  | Viewing Angle (Deg)      | $\theta x 1$    | $CR \geq 2$<br>$V_{LCD} = 4.5V$    | +25       | +20         | +35                | +25                | +35                 | +35                        | 7.1.2 |
|    |                          | $\theta x 2$    |                                    | -25       | -20         | -35                | -25                | -35                 | -40                        |       |
|    |                          | $\theta y 1$    |                                    | -30       | -25         | -35                | -30                | -35                 | -35                        |       |
|    |                          | $\theta y 2$    |                                    | +30       | +25         | +35                | +30                | +35                 | +35                        |       |
| 3  | Contrast Ratio           | CR              | $\theta = 0^0$<br>$V_{LCD} = 4.5V$ | 3.0       | 2.3         | 6.0                | 3.0                | 6.0                 | 20                         | 7.1.3 |
| 4  | Response Time (msec)     | Rise Time (Tr)  | $\theta = 0^0$                     | 200       |             |                    |                    |                     |                            | 7.1.4 |
|    |                          | Decay Time (Td) | $\theta = 0^0$                     | 250       |             |                    |                    |                     |                            |       |

## Note:

1. Viewing angle data is based on bottom view product by default. Should it be a top view product, values are then swap.
2. Contrast ratio is based on typical data when using white colour as backlight.
3. Equipment Used Eldim; Ez Contrast 120R , Spot Size = 2mm

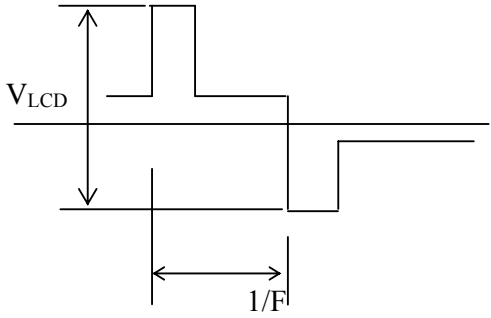
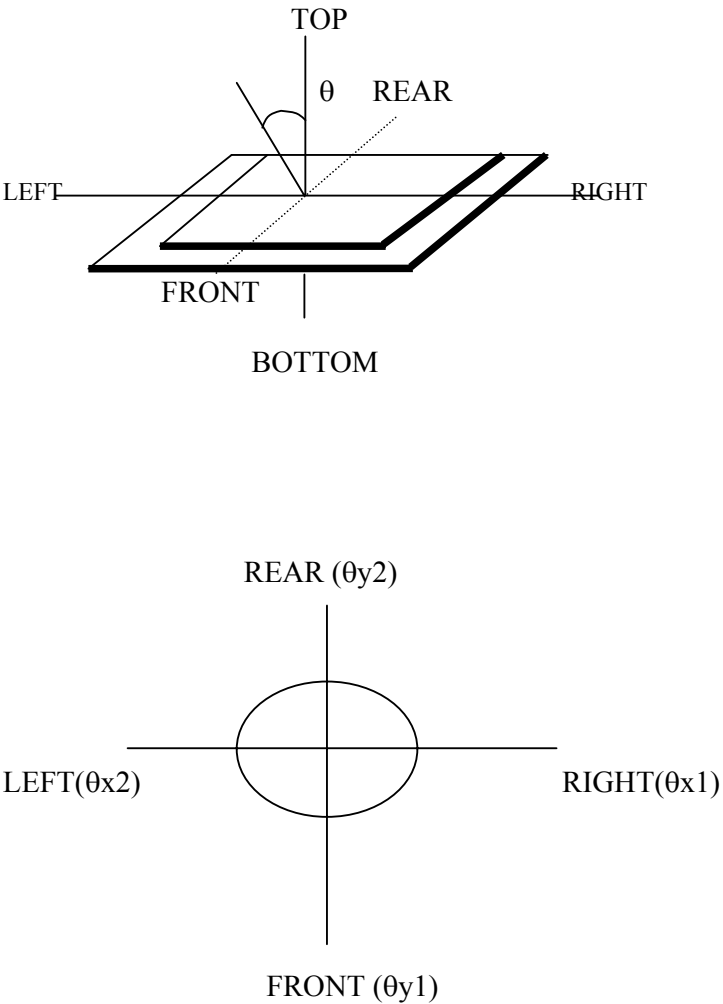

| NO    | CHARACTERISTICS   | DEFINITIONS  |
|-------|---|--|
| 7.1.1 | <b>Definition of Operating Voltage (<math>V_{LCD}</math>)</b> |  <p><math>V_{LCD}</math> : Operating Voltage<br/>F : Frame Frequency</p>   |
| 7.1.2 | <b>Definition of Viewing Angle</b>                            |  <p>Diagram illustrating the viewing angle definition. The top diagram shows a 3D perspective of the display panel with axes labeled TOP, REAR, LEFT, RIGHT, FRONT, and BOTTOM. The viewing angle <math>\theta</math> is shown between the normal to the panel and the viewing direction. The bottom diagram shows a 2D representation of the viewing angle with axes labeled REAR (<math>\theta_{y2}</math>), FRONT (<math>\theta_{y1}</math>), LEFT (<math>\theta_{x2}</math>), and RIGHT (<math>\theta_{x1}</math>).</p> |

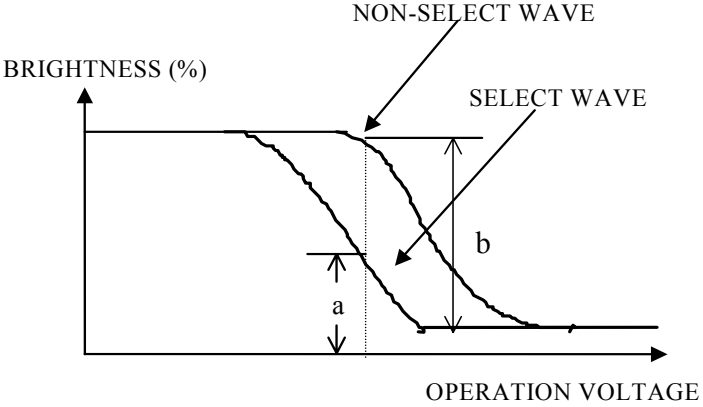
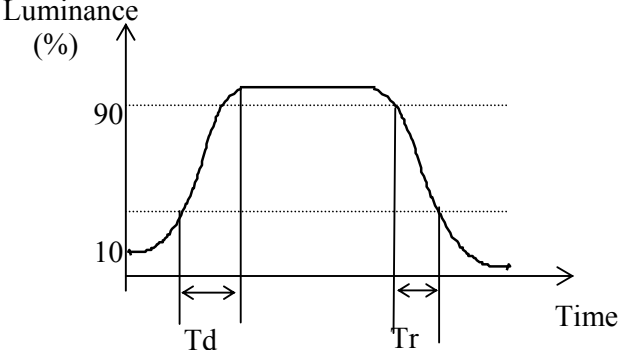

|              |  |   |
|--------------|--|---|
| <p>7.1.3</p> | <p><b>Definition of Contrast Ratio</b></p> |  <p>Contrast Ratio = <math>\frac{\text{Brightness of non-selected state (b)}}{\text{Brightness of selected state (a)}}</math></p> <p><b>Conditions</b></p> <ul style="list-style-type: none"><li>(a) Operating Voltage: <math>V_{LCD}</math></li><li>(b) Temperature: <math>25^{\circ}C</math></li><li>(c) Viewing Angle, <math>\theta = 0^{\circ}</math></li></ul> |
| <p>7.1.4</p> | <p><b>Response Time</b></p>                |  <p><math>T_r</math>: Measured between 10% and 90% of LCD segment maximum response with <math>V_{ON}</math>.</p> <p><math>T_d</math>: With voltage switches to zero and the instant LCD segment reaches 10% of its maximum response.</p>  |



8.0 Interface

| Pin No. | Symbol | Function                |
|---------|--------|-------------------------|
| 1       | GND    | Ground                  |
| 2       | V5     | Driving supply voltage  |
| 3       | VDD    | Logic power supply      |
| 4       | RS     | Register select input   |
| 5       | R/W    | Read and write input    |
| 6       | E      | Read/Write start signal |
| 7       | DB0    | Data input              |
| 8       | DB1    | Data input              |
| 9       | DB2    | Data input              |
| 10      | DB3    | Data input              |
| 11      | DB4    | Data input              |
| 12      | DB5    | Data input              |
| 13      | DB6    | Data input              |
| 14      | DB7    | Data input              |



9.0 Timing characteristics / Timing diagrams

Read Operation

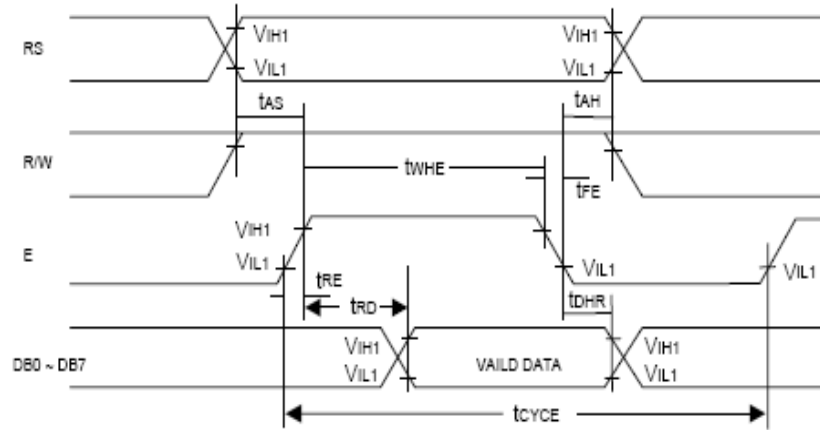

Figure 1. Bus Read Operation Sequence  
(Reading out data from NT7605 to MPU)

Write Operation

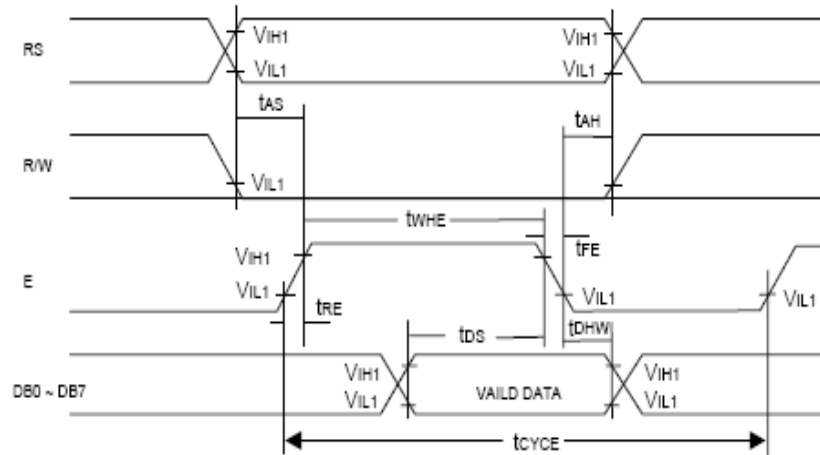

Figure 2. Bus Write Operation Sequence  
(Writing data from MPU to NT7605)

**Read Cycle**

| Symbol                            | Parameter                    | Min.             | Typ. | Max. | Unit | Conditions |
|-----------------------------------|------------------------------|------------------|------|------|------|------------|
| t <sub>CYCE</sub>                 | Enable Cycle Time            | 500              | -    | -    | ns   | Figure 1   |
| t <sub>WHE</sub>                  | Enable "H" Level Pulse Width | 300              | -    | -    | ns   | Figure 1   |
| t <sub>RE</sub> , t <sub>FE</sub> | Enable Rise/Fall Time        | -                | -    | 25   | ns   | Figure 1   |
| t <sub>AS</sub>                   | RS, R/W Setup Time           | 60 <sup>1</sup>  | -    | -    | ns   | Figure 1   |
|                                   |                              | 100 <sup>2</sup> |      |      |      |            |
| t <sub>AH</sub>                   | RS, R/W Address Hold Time    | 10               | -    | -    | ns   | Figure 1   |
| t <sub>RD</sub>                   | Read Data Output Delay       | -                | -    | 190  | ns   | Figure 1   |
| t <sub>DHR</sub>                  | Read Data Hold Time          | 20               | -    | -    | ns   | Figure 1   |

**Write Cycle**

| Symbol                            | Parameter                    | Min.             | Typ. | Max. | Unit | Conditions |
|-----------------------------------|------------------------------|------------------|------|------|------|------------|
| t <sub>CYCE</sub>                 | Enable Cycle Time            | 500              | -    | -    | ns   | Figure 2   |
| t <sub>WHE</sub>                  | Enable "H" Level Pulse Width | 300              | -    | -    | ns   | Figure 2   |
| t <sub>RE</sub> , t <sub>FE</sub> | Enable Rise/Fall Time        | -                | -    | 25   | ns   | Figure 2   |
| t <sub>AS</sub>                   | RS, R/W Setup Time           | 60 <sup>1</sup>  | -    | -    | ns   | Figure 2   |
|                                   |                              | 100 <sup>2</sup> |      |      |      |            |
| t <sub>AH</sub>                   | RS, R/W Address Hold Time    | 10               | -    | -    | ns   | Figure 2   |
| t <sub>DS</sub>                   | Data Output Delay            | 150              | -    | -    | ns   | Figure 2   |
| t <sub>DHW</sub>                  | Data Hold Time               | 10               | -    | -    | ns   | Figure 2   |

Notes: 1: 8-bit operation mode  
2: 4-bit operation mode



Interface with 8-bit MPU

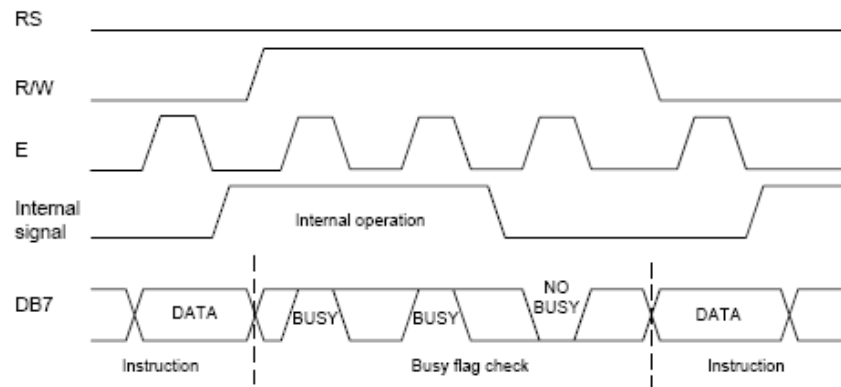

Interface with 4-bit MPU

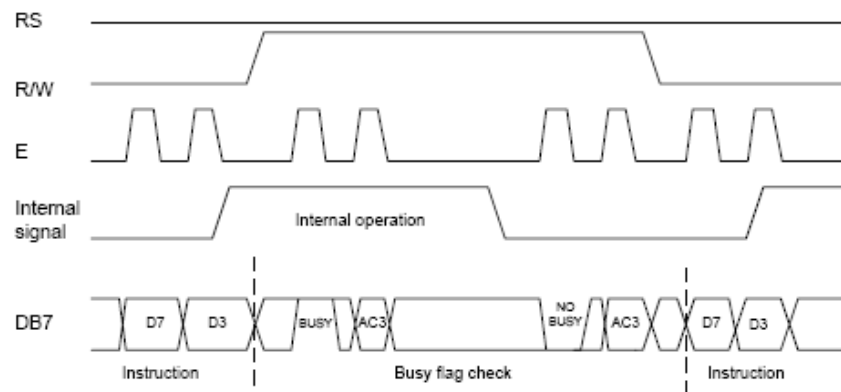



10. Application Block Diagram/Circuit

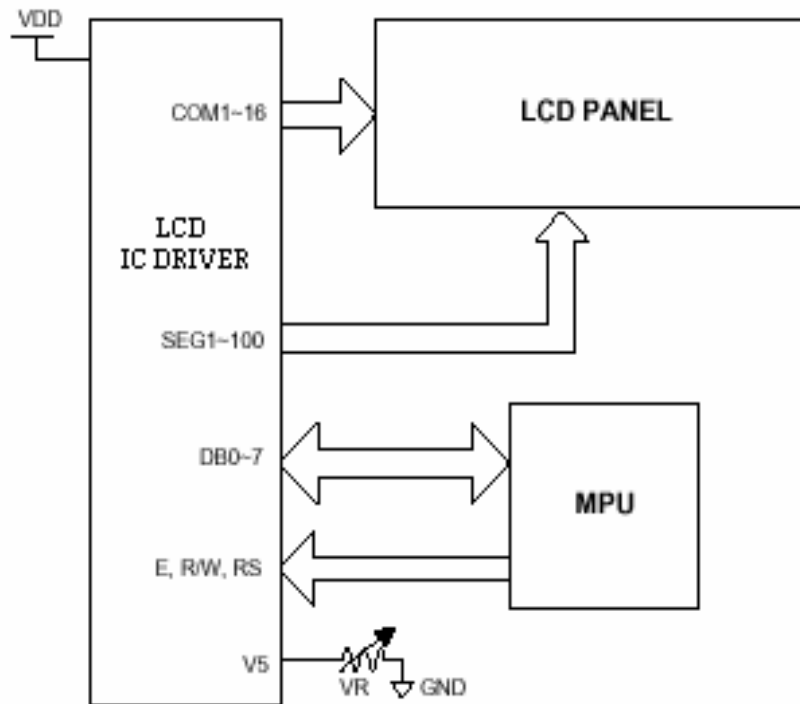



11. Instructions

| Instruction                     | Code |    |            |     |     |     |      |                               |  |  | Function   | Execution time (max)<br>(fosc = 250kHz) |
|---------------------------------|------|----|------------|-----|-----|-----|------|-------------------------------|--|--|--|---|
|                                 | RS   | RW | DB7        | DB6 | DB5 | DB4 | DB3  | DB2                           | DB1  | DB0  |  |   |
| Display Clear                   | 0    | 0  | 0          | 0   | 0   | 0   | 0    | 0                             | 0  | 1  | Clear entire display area, restore display from shift, and load address counter with DDRAM address 00h.                        | 1.64ms                                  |
| Display/ Cursor Home            | 0    | 0  | 0          | 0   | 0   | 0   | 0    | 0                             | 0  | 1 *  | Restore display from shift and load address counter with DDRAM address 00h.  | 1.64ms                                  |
| Entry Mode Set                  | 0    | 0  | 0          | 0   | 0   | 0   | 0    | 1                             | I/ D   | S  | Specify direction of cursor movement and display shift mode. This operation takes place after each data transfer (read/write). | 40us                                    |
| Display ON/OFF                  | 0    | 0  | 0          | 0   | 0   | 0   | 1    | D                             | C  | B  | Specify activation of display (D) cursor (C) and blinking of character at cursor position (B).                                 | 40us                                    |
| Display/ Cursor Shift           | 0    | 0  | 0          | 0   | 0   | 1   | S/ C | R/ L                          | *  | *  | Shift displays or move cursor.   | 40us                                    |
| Function Set                    | 0    | 0  | 0          | 0   | 1   | D L | 1    | 0                             | *  | *  | Set interface data length (DL :8 bit/4 bit)  | 40us                                    |
| RAM Address Set                 | 0    | 0  | 0          | 1   | ACG |     |      |                               |  | Load the address counter with a CGRAM address. Subsequent data access is for CGRAM data. |  | 40us                                    |
| DDRAM Address Set               | 0    | 0  | 1          | ADD |     |     |      |                               | Load the address counter with a DDRAM address. Subsequent data access is for DDRAM data. |  | 40us   |   |
| Busy Flag/ Address Counter Read | 0    | 1  | B F        | AC  |     |     |      |                               | Read Busy Flag(BF) and contents of Address Counter (AC)                                  |  | 40us   |   |
| CGRAM/ DDRAM Data Write         | 1    | 0  | Write data |     |     |     |      | Write data to CGRAM or DDRAM  |  | 40us   |  |   |
| CGRAM/ DDRAM Data Read          | 1    | 1  | Read data  |     |     |     |      | Read data from CGRAM or DDRAM |  | 40us   |  |   |
| CGRAM/ DDRAM Data Read          | 1    | 1  | Read data  |     |     |     |      | Read data from CGRAM or DDRAM |  | 40us   |  |   |

Note: Symbol “\*” signifies an insignificant bit (disregard)



DDRAM : Display Data RAM  
CGRAM : Character Generator RAM  
ACG : Character Generator RAM Address  
ADD : Display Data RAM Address  
AC : Address Counter

|         |                         |         |               |
|---------|-------------------------|---------|---------------|
| I/D = 1 | : Increment             | I/D = 0 | : Decrement   |
| S = 1   | : Display Shift On      |         |               |
| D = 1   | : Display On            |         |               |
| C = 1   | : Cursor Display On     |         |               |
| B = 1   | : Cursor Blink On       |         |               |
| S/C = 1 | : Shift Display         | S/C = 0 | : Move Cursor |
| R/L = 1 | : Shift Right           | R/L = 0 | : Shift Left  |
| DL = 1  | : 8-bit                 | DL = 0  | : 4-bit       |
| BF = 1  | : Internal Operation    |         |               |
| BF = 0  | : Ready for Instruction |         |               |



Character Generator ROM (NT7605)

|  |   | Higher 4-bit (D4 to D7) of Character Code (Hexadecimal) |    |   |   |   |   |   |   |   |   |   |   |   |   |   |   |   |
|--|---|---|----|---|---|---|---|---|---|---|---|---|---|---|---|---|---|---|
|  |   | 0   | 1  | 2 | 3 | 4 | 5 | 6 | 7 | 8 | 9 | A | B | C | D | E | F |   |
| Lower 4-bit (D0 to D3) of Character Code (Hexadecimal) | 0 | CG RAM (1)  |    |   | 0 | P | \ | P |   |   |   |   | 一 | 夕 | ε | ο | ρ |   |
|  | 1 | CG RAM (2)  | !  | 1 | A | Q | a | q |   |   |   |   | ⊠ | フ | チ | ク | ⊠ | ⊠ |
|  | 2 | CG RAM (3)  | "  | 2 | B | R | b | r |   |   |   |   | ” | イ | ツ | × | ⊠ | ⊠ |
|  | 3 | CG RAM (4)  | #  | 3 | C | S | c | s |   |   |   |   | 」 | ウ | テ | ε | ε | ε |
|  | 4 | CG RAM (5)  | \$ | 4 | D | T | t | t |   |   |   |   | √ | エ | ト | ⊠ | ⊠ | ⊠ |
|  | 5 | CG RAM (6)  | %  | 5 | E | U | u | u |   |   |   |   | • | オ | + | ⊠ | ⊠ | ⊠ |
|  | 6 | CG RAM (7)  | &  | 6 | F | V | v | v |   |   |   |   | ツ | カ | ニ | ⊠ | ⊠ | ⊠ |
|  | 7 | CG RAM (8)  | '  | 7 | G | W | w | w |   |   |   |   | フ | キ | ヌ | フ | ⊠ | ⊠ |
|  | 8 | CG RAM (1)  | (  | 8 | H | X | x | x |   |   |   |   | √ | コ | ホ | ル | ル | ⊠ |
|  | 9 | CG RAM (2)  | )  | 9 | I | Y | y | y |   |   |   |   | ε | ク | ル | ル | ル | ⊠ |
|  | A | CG RAM (3)  | *  | * | J | Z | z | z |   |   |   |   | ε | コ | ル | ル | ル | ⊠ |
|  | B | CG RAM (4)  | +  | + | K | ⊠ | ⊠ | ⊠ |   |   |   |   | ⊠ | カ | ⊠ | ⊠ | ⊠ | ⊠ |
|  | C | CG RAM (5)  | ,  | , | L | ⊠ | ⊠ | ⊠ |   |   |   |   | ⊠ | カ | ⊠ | ⊠ | ⊠ | ⊠ |
|  | D | CG RAM (6)  | -  | - | M | ⊠ | ⊠ | ⊠ |   |   |   |   | ⊠ | カ | ⊠ | ⊠ | ⊠ | ⊠ |
|  | E | CG RAM (7)  | .  | . | N | ⊠ | ⊠ | ⊠ |   |   |   |   | ⊠ | カ | ⊠ | ⊠ | ⊠ | ⊠ |
|  | F | CG RAM (8)  | /  | / | O | ⊠ | ⊠ | ⊠ |   |   |   |   | ⊠ | カ | ⊠ | ⊠ | ⊠ | ⊠ |



12.0 Quality Assurance

12.1 ZONE DEFINITION

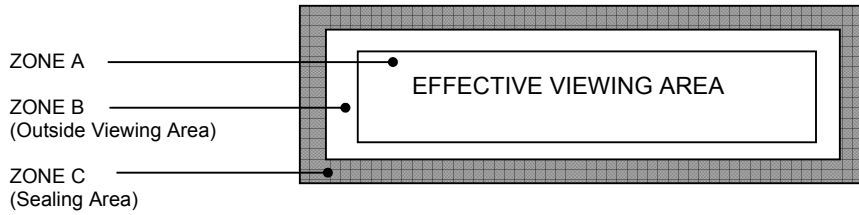

12.1.1 Black Spot, White Spot and Foreign Material

| Defect Category                             | Defect Description                          | Criterion                     |                |    | Drawing Specification |                      |
|---|---|-------------------------------|----------------|----|-----------------------|----------------------|
| Black Spot, White Spot and Foreign Material | Black Spot, White Spot and Foreign Material | Zone / Dimension              | Acceptable No. |    |                       | <p>D = (A + B)/2</p> |
|   |   |                               | A              | B  | C                     |                      |
|   |   | $D \leq 0.10\text{mm}$        | NC             | NC | NC                    |                      |
|   |   | $0.10 < D \leq 0.20\text{mm}$ | 3              | 3  | NC                    |                      |
|   |   | $0.20 < D \leq 0.30\text{mm}$ | 1              | 2  | NC                    |                      |
|   |   | $D > 0.30\text{ mm}$          | 0              | 0  | NC                    |                      |
| NC: No count                                |   |                               |                |    |                       |                      |
| D: Mean Diameter of Defect                  |   |                               |                |    |                       |                      |

12.1.2 Line Shape and Scratches

| Defect Category          | Defect Description       | Criterion       |                |    | Drawing Specification |  |    |
|--------------------------|--------------------------|-----------------|----------------|----|-----------------------|--|----|
| Line shape and scratches | Line shape and scratches | Zone /Dimension | Acceptable No. |    |                       |  |    |
|                          |                          | X               | Y              | A  | B                     |  | C  |
|                          |                          | -               | <0.01mm        | NC | NC                    |  | NC |
|                          |                          | < 2 mm          | < 0.02mm       | 1  | 1                     |  | NC |
|                          |                          | <1 mm           | < 0.0 2mm      | 1  | 2                     |  | NC |

12.1.3 Pin Hole

| Defect Category | Defect Description                  | Criterion                                    | Drawing Specification |
|-----------------|-------------------------------------|--|-----------------------|
| Pin Hole        | Pin hole / void at light up segment | $D \leq 0.20\text{mm}$ within 1 part/segment | <p>D = (A + B)/2</p>  |



12.1.4 Polarizer Bubble/Foreign Material

| Defect Category               | Defect Description                  | Criterion   | Drawing Specification |                |  |  |   |   |   |                        |    |    |    |                               |   |   |    |                               |   |   |    |                              |   |   |    |                                   |
|-------------------------------|-------------------------------------|---|-----------------------|----------------|--|--|---|---|---|------------------------|----|----|----|-------------------------------|---|---|----|-------------------------------|---|---|----|------------------------------|---|---|----|-----------------------------------|
|                               | Polarizer bubble / Foreign material | <table border="1"> <thead> <tr> <th rowspan="2">Zone / Dimension</th> <th colspan="3">Acceptable No.</th> </tr> <tr> <th>A</th> <th>B</th> <th>C</th> </tr> </thead> <tbody> <tr> <td><math>D \leq 0.15\text{mm}</math></td> <td>NC</td> <td>NC</td> <td>NC</td> </tr> <tr> <td><math>0.15 &lt; D \leq 0.30\text{mm}</math></td> <td>3</td> <td>5</td> <td>NC</td> </tr> <tr> <td><math>0.30 &lt; D \leq 0.50\text{mm}</math></td> <td>2</td> <td>3</td> <td>NC</td> </tr> <tr> <td><math>0.50 &lt; D \leq 1.0\text{mm}</math></td> <td>0</td> <td>1</td> <td>NC</td> </tr> </tbody> </table> <p>NC: No count<br/>D: Mean Diameter of Defect<br/>Accept - if air bubble at the seal area does not propagate into effective viewing area</p> | Zone / Dimension      | Acceptable No. |  |  | A | B | C | $D \leq 0.15\text{mm}$ | NC | NC | NC | $0.15 < D \leq 0.30\text{mm}$ | 3 | 5 | NC | $0.30 < D \leq 0.50\text{mm}$ | 2 | 3 | NC | $0.50 < D \leq 1.0\text{mm}$ | 0 | 1 | NC | <p><math>D = (A + B)/2</math></p> |
| Zone / Dimension              | Acceptable No.                      |   |                       |                |  |  |   |   |   |                        |    |    |    |                               |   |   |    |                               |   |   |    |                              |   |   |    |                                   |
|                               | A                                   | B   | C                     |                |  |  |   |   |   |                        |    |    |    |                               |   |   |    |                               |   |   |    |                              |   |   |    |                                   |
| $D \leq 0.15\text{mm}$        | NC                                  | NC  | NC                    |                |  |  |   |   |   |                        |    |    |    |                               |   |   |    |                               |   |   |    |                              |   |   |    |                                   |
| $0.15 < D \leq 0.30\text{mm}$ | 3                                   | 5   | NC                    |                |  |  |   |   |   |                        |    |    |    |                               |   |   |    |                               |   |   |    |                              |   |   |    |                                   |
| $0.30 < D \leq 0.50\text{mm}$ | 2                                   | 3   | NC                    |                |  |  |   |   |   |                        |    |    |    |                               |   |   |    |                               |   |   |    |                              |   |   |    |                                   |
| $0.50 < D \leq 1.0\text{mm}$  | 0                                   | 1   | NC                    |                |  |  |   |   |   |                        |    |    |    |                               |   |   |    |                               |   |   |    |                              |   |   |    |                                   |

Note: Total defects shall not exceed five

12.2 TERMINAL PIN DEFECTS

| Defect Category       | Defect Description                                     | Criterion  | Drawing Specification                             |
|-----------------------|--|--|---|
| Pin attachment defect | Distorted pins   | Distorted angle shall $\leq 5^{\circ}$<br>$\theta \leq 5^{\circ}$  |   |
|                       | Damage or no plated pins                               | Reject   |   |
|                       | Pin corrosion or foreign material on pin               | Reject   |   |
|                       | Broken, loose, missing or extra pins insert to display | Reject   |   |
|                       | Burrs at the tip of the pin leg                        | Reject - if total thickness > pin thickness + 0.076mm  | <p>Max = pin thickness + 0.076mm</p>              |
|                       | Poor pin insertion                                     | 1- Pin should be fully inserted into the glass.<br>2- Reject – if the maximum width between pins exceed 0.635mm than the display width | <p><math>(Pw - Dw) \leq 0.635\text{mm}</math></p> |

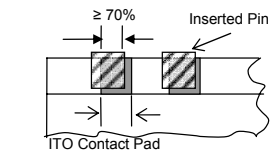
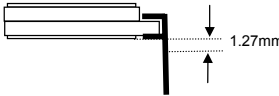
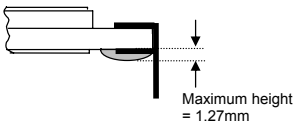

|                              |  |   |
|------------------------------|--|---|
| Pin Misregistration          | 1-Pin head must be on ITO contact pad or should cover at least 70% of the ITO contact pads<br>2-Reject – if pin head contact both ITO contact pad.<br>3-Reject - if pin head not in contact with ITO contact pad |  |
| Epoxy flows onto pins        | Accept - if epoxy flow not exceed maximum height of 1.27mm (Measuring from the surface of back polarizer) and should not cause any functional defect   |  |
| Epoxy height on bottom glass | Reject – if height of epoxy at bottom glass > 1.27mm   |  |
| Epoxy on polarizer           | Reject   |   |

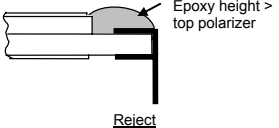
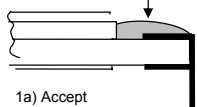
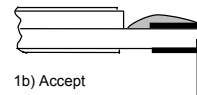
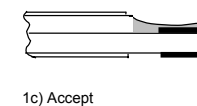
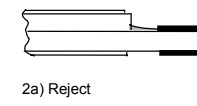
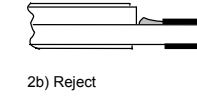
| Defect Category       | Defect Description                  | Criterion  | Drawing Specification  |
|-----------------------|-------------------------------------|--|--|
| Pin attachment defect | Epoxy height exceed front polarizer | Reject   |    |
|                       | Epoxy coverage                      | Epoxy should cover all pin head including touching the glass on both sides of single prong.<br><br>Figure 1a), 1b) and 1c) are acceptable<br><br>Split/crack epoxy, which exposes the prong, is rejected<br>Figure 2a), 2b) and 2c) are rejected |  1a) Accept<br> 1b) Accept<br> 1c) Accept<br> 2a) Reject<br> 2b) Reject |



|                |  |  |  |
|----------------|--|--|--|
|                |  |  | <p>Epoxy Split    Inserted Pin</p> <p>2c) Reject</p>   |
| Epoxy bridging | <p>Epoxy bridging should not exceed forming portion of pin</p> <p>Figure 1a) accepted</p> <p>Figure 2a) rejected</p> |  | <p>1a) Accept</p> <p>Epoxy not exceed forming portion</p> <p>2a) Reject</p> <p>Epoxy exceed forming portion</p> <p>Forming portion</p> |

| Defect Category       | Defect Description                   | Criterion   | Drawing Specification |
|-----------------------|--------------------------------------|---|-----------------------|
| Pin attachment defect | Graphite on pins                     | Accept - if graphite not exceed maximum height of 1.27mm (Measuring from the surface of back polarizer) and should not cause any functional short | <p>1.27mm</p>         |
|                       | Graphite bridging                    | Reject – if bridging of graphite material from one terminal to another causes functional short  |                       |
|                       | Missing graphite                     | Reject - if graphite between terminal pin and its contact pad missing   |                       |
|                       | Graphite on polarizer and glass edge | Criterion should be as 12.1.1 and should not cause any functional short   |                       |



### 13. Precaution for using LCM

#### 1. Liquid Crystal Display (LCD)

LCD is made up of glass, organic sealant, organic fluid and polymer based polarizers. The following precautions should be taken when handling.

- b) Keep the temperature within the range of use and storage. Excessive temperature and humidity could cause polarization degradation, polarizer peel off or bubble.
- c) Do not contact the exposed polarizer with anything harder than HB pencil lead. To clean dust off the display surface, wipe gently with cotton, chamois or other soft material soaked in petroleum benzine.
- d) Wipe off saliva or water drops immediately. Contact with water over a long period of time may cause polarizer deformation or colour fading, while an active LCD with water condensation on its surface will cause corrosion of ITO electrodes.
- e) Glass can be easily chipped or cracked from rough handling, especially at corners and edges.
- f) Do not drive LCD with DC voltage.

#### 2. Liquid Crystal Display Modules.

##### 2.1 Mechanical Considerations

LCM are assembled and adjusted with a high degree of precision. Avoid excessive shocks and do not make any alterations or modification. The following should be noted.

- a) Do not tamper in any way with the tabs on the metal frame.
- b) Do not modify the PCB by drilling extra holes, changing its outline, moving its component or modifying its pattern.
- c) Do not touch the elastomer connector, especially insert a backlight panel (for example, EL)
- d) When mounting a LCM make sure that the PCB is not under any stress such as bending or twisting. Elastomer contacts are very delicate and missing pixels could result from slight dislocation of any of the elements.

- a) Avoid pressing on the metal bezel, otherwise the elastomer connector could be deformed and lose contact, resulting in missing pixels.

##### 2.2 Static Electricity

LCM contains CMOS LSI's and the same precaution for such devices should apply, namely

- a) The operator should be grounded whenever he/she comes into contact with the module. Never touch any of the conductive parts such as the LSI pads, the copper leads on the PCB and the interface terminals with any parts of the human body.
- b) The modules should be kept in antistatic bags or other containers to static for storage.
- c) Only properly grounded soldering irons should be used.
- d) If an electric screwdriver is used, it should be well grounded and shielded from commutator spark.
- e) The normal static prevention measures should be observed for work clothes and working benches, the latter conductive (rubber) mat is recommended.
- f) Since dry air is inductive to statics, a relative humidity of 50-60% is recommended.

##### 2.3 Soldering

- a) Solder only to the I/O terminals.
- b) Use only soldering irons with proper grounding and no leakage.
- c) Soldering temperature: 280 °C
- d) Soldering time: 3 to 4 sec
- e) Use eutectic solder with resin flux fill.
- f) If flux is used, the LCD surface should be covered to avoid flux spatters. Flux residue should be removed afterwards.



#### 2.4 Operation

- a) The contrast can be adjusted by varying the LCD driving voltage  $V_0$
- b) Driving voltage should be kept within specified range, excess voltage shortens display life.
- c) Response time increases with decrease in temperature.
- d) Display may turn black or dark blue at temperature above its operational range, this is (however not pressing on the viewing area) may cause the segments to appear “fractured”.
- e) Mechanical disturbance during operation (such as pressing on the viewing area) may cause the segments to appear “fractured”.

#### 2.5 Storage

If any fluid leaks out of the damaged glass cell, wash off any human part that comes into contact with soap and water. Never swallow the fluid. The toxicity is extremely low but caution should be exercised at all the time.

#### 2.6 Limited Warranty

Unless otherwise agreed between Crystal Clear Technology and customer, Crystal Clear Technology will replace or repair any of its LCD and LCM which is found to be defective electrically and visually when inspected in accordance with Crystal Clear Technology acceptance standards, for a period of one year from date of shipment. Confirmation of such date shall be based on freight documents. The warranty liability of Crystal Clear Technology is limited to repair and/or replacement on the terms set forth above. Crystal Clear Technology will not be responsible for any subsequent or consequential events.

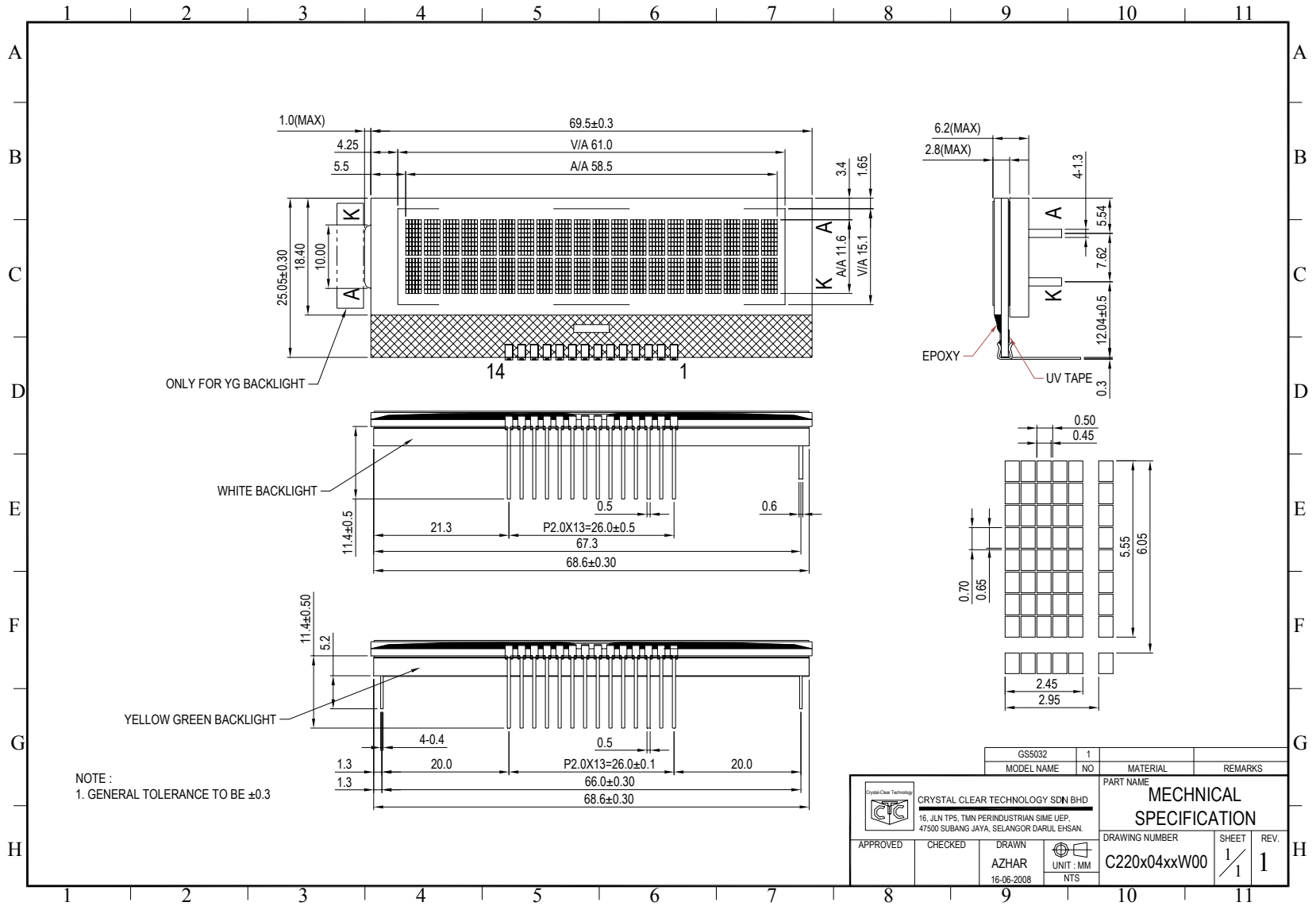



**Crystal Clear Technology**  
16 Jalan TP5—Taman Perindustrian Sime UEP  
47600 Subang Jaya—Selangor DE  
Malaysia